

# HEWLETT-PACKARD JOURNAL



JULY 1969



# Real-Time Measurement and On-Line Processing of Acoustical and Other Audio-Frequency Spectra

*Almost any acoustical quantity can be determined by measuring and suitably processing the frequency spectra of sounds. All it takes is this new real-time audio spectrum analyzer married to a general-purpose digital computer.*

By Wisu T. Kapuskar and Christopher J. Balmforth

THE HUMAN SENSATION OF HEARING is governed by complex physiological and psychological mechanisms. Trying to discover what these mechanisms are and how they work, scientists have collected large amounts of data relating individual aspects of the sensation of hearing to such physical quantities as sound pressure, particle velocity, and sound intensity. However, real progress in understanding hearing has been disappointingly slow, in large part because the available analytical methods have been woefully inadequate to deal with the superabundance of data that must be analyzed. Not surprisingly, computers are now being seen as a solution. Advances in data processing are opening up many new possibilities in acoustical instrumentation. We may now be in a position to find answers to many of our long-standing questions about hearing, and we can expect

these new developments to bring to acoustical research a fresh momentum, greater than any it has ever had before.

It seems fair to say that the first significant advance in subjective acoustics was the adequate evaluation of our sensation of loudness. The HP Model 8051A Loudness Analyzer<sup>[1]</sup> is basically an analog computer dedicated to the single function of measuring loudness according to Zwicker's method (ISO Recommendation R532, Method B). By this method, loudness is computed as a complex function of the frequencies, bandwidths, and frequency separations of the components of a sound<sup>[2],[3]</sup>. The calculations would be tedious and time-consuming without the loudness analyzer.

## General-Purpose Audio Data Processor

Powerful as the loudness analyzer is, it measures only loudness. An even more powerful system, a flexible one that can make nearly any kind of audio measurement, and one that is easily adapted to changes in investigative methods or standards, is the HP Model 80501A Audio Data Processor, a combination of a digital computer and a third-octave real-time audio spectrum analyzer. Besides acoustic research, the system has applications in noise abatement, vibration testing, speech analysis, and in the analysis of many other audio-frequency and sub-audio-frequency phenomena.

The audio data processor is shown in Fig. 1. Fig. 2 is its block diagram. In its simplest form, the system may consist only of a teleprinter, the computer, and the analyzer. A high-speed punched tape reader and a high-

**Cover:** This is the central processing unit of the HP Model 80500A Aircraft Noise Monitoring System at Stuttgart Airport. The CPU receives noise-level information from seven remote noise-monitoring terminals and informs the operator when noise levels exceed preset thresholds.

**In this Issue:** Real-Time Audio Spectrum Analysis and Processing; **page 2.** Monitoring Airport Noise; **page 11.** Low-Frequency Network Analysis; **page 16.**



speed tape punch would be added to increase the input and output rates. Additional peripherals, such as incremental magnetic tape, X-Y plotter, CRT display, and so forth, can readily be incorporated in the system since each peripheral can be connected to the computer through a standard plug-in interface card.

### Real-Time Audio Spectrum Analyzer

The HP Model 8054A Real-Time Audio Spectrum Analyzer is a fully computer-compatible instrument. By means of a duplex register the computer can select and direct all the functions of the analyzer. Information from the analyzer is in digital form, and is transferred to the computer through a standard data source interface card.

Equipped with a suitable microphone, the analyzer (Fig. 3) measures the unweighted physical spectrum of sound, in contrast with the Model 8051A Loudness Analyzer, which applies weighting factors to the spectrum and computes loudness. Using active filters, the analyzer divides the audio spectrum into twenty-four  $\frac{1}{3}$ -octave channels. The center frequencies of these channels conform both to ISO R266 and to USAS S1.6-1960. In standard instruments, center frequencies for the first and twenty-fourth channels are 50 Hz and 10 kHz, respectively. A wide variety of other filter combinations and center-band frequencies is available in the range 2 Hz through 40 kHz. Filter characteristics meet the requirements of USAS S1.11-1966 Class III third-octave filters, specifications which are superior to those of IEC 225. With the optional 12 channel addition (HP 8060A) the basic instrument may be extended to 36 channels. Each channel has its own detector; all are scanned every 28 milliseconds, and outputs are displayed on a CRT. Fig. 4 shows a photograph of a typical display. For all practical purposes, the data are available at the same time the measured phenomena occur, so the instrument is properly regarded as a real-time analyzer.

The analyzer has four display modes: rms fast, rms slow, peak, and hold. In the hold mode the display is frozen. The peak mode provides true peak detection, and a partial 'hold' action in which a spectral line on the display can only *increase* in amplitude. On an optional basis, maximum rms detection can be substituted for peak detection. The dynamic

characteristics of the rms modes are as specified in IEC 179. The nominal time constants of the standard unit are 0.1 and 1 second, and other time constants are optional. To serve their purposes, the rms detectors had to be made extremely linear and with wide dynamic range. For example, to measure toneburst signals with crest factors of 5 over a dynamic range of 40 dB with an accuracy of  $\pm 1$  dB, a detector must handle signals which differ by 64 dB. If the maximum output swing is 50 volts, then the minimum signal (limited by drift or diode offset voltage) is less than 30 millivolts.

### Inside the Analyzer

A block diagram of the analyzer is shown in Fig. 5. Input signals may originate in a microphone, a trans-



**Fig. 1.** Model 80501A Audio Data Processor consists of a real-time audio spectrum analyzer (with CRT) which measures the frequency spectra of audio-frequency inputs, a digital computer which processes the measured spectra, and peripheral devices. A typical application is aircraft noise analysis and evaluation. Real-time processing gives results almost immediately so appropriate action can be taken if required.



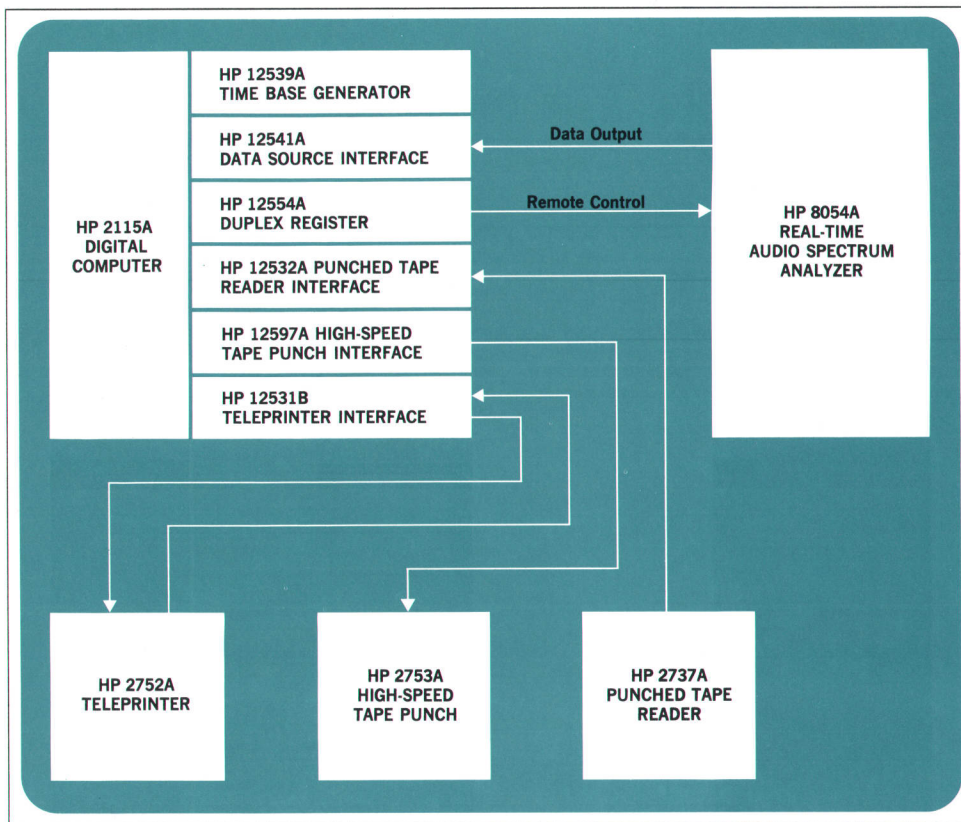

**Fig. 2.** The computer completely controls the analyzer's operation, even adjusting its range according to the input level. Additional peripherals or analyzers can be incorporated into the system simply by plugging standard interface cards into the computer.

ducer, or another electrical source such as a tape recorder. The analyzer contains circuitry to accommodate precision condenser microphones, such as HP's 15109B or 15119A.

The input signal is applied to a preamplifier which drives the third-octave filters, either directly or through an optional network. The optional network might, for example, apply pre-emphasis to increase the effective dynamic range of the instrument. As an alternative, some sort of weighting network might be used, say for correcting the nonlinearities of the input transducer.

The signal is applied in parallel to the third-octave filters. Each filter feeds its own detector, rms or peak, as the case may be, and its own storage circuit. Each storage circuit is scanned by shift register I for the CRT display and by shift register II for external equipment and for the front panel digital voltmeter display. Shift register I operates at a clock rate of 1 kHz. This register also triggers the horizontal sweep, so as to synchronize the position of the CRT beam with the appropriate channel. After the 24th channel is displayed, range is shown on the CRT. The range indication is a vertical bar (see Fig. 4) showing which 40 dB 'window' from the instrument's total 140 dB range is on display. The entire cycle,

including range display, requires only 28 milliseconds.

Shift register II scans the storage output for external equipment. If the instrument is driving an X-Y recorder, this register generates an X-axis output voltage that is synchronized with the switching of the channels. The rate is fixed at 1 channel per second. For faster equipment, such as the digital computer that is used in the audio data processor system, the maximum shift rate is 1 channel per millisecond.

A brightened segment of the CRT trace identifies which channel is currently selected by shift register II. At the same time, that channel's front-panel pushbutton is illuminated. The front-panel digital display, driven by the analog-to-digital converter, indicates the signal level of the selected channel. The readout is in dB above 1 microvolt, independent of the range that is selected for display on the CRT.

Even if the output from some channels should be considerably above the selected maximum level, the indicated measurement will be valid so long as the preamplifier is not overloaded. An overload indicator on the front panel of the instrument warns of such a condition, and the computer identifies an overloaded channel by reading a value of 400 dB for it.



**Fig. 3.** Model 8054A Real-Time Audio Spectrum Analyzer divides the audio spectrum into 24 third-octave frequency bands and measures the rms or peak value of the signal in each band. Results are displayed on the CRT. Single bands can be selected for digital readout.

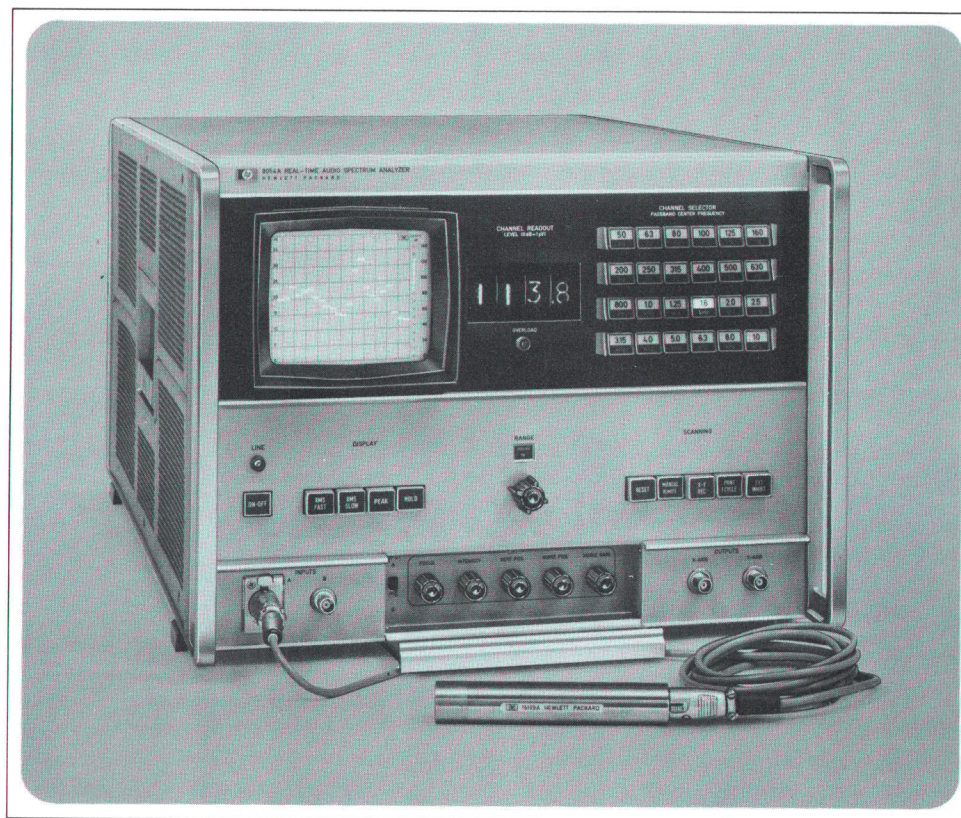

The analyzer connects to the computer through two cables, one for control and one for data output. All of the front panel controls can also be effected by contact closures at the remote connector; thus they can be commanded by the computer by way of the standard duplex register. The analyzer delivers its output in digital form, identifying channel number while presenting band level. The analyzer can be treated by the computer as if it were a conventional digital voltmeter or counter; thus the computer can receive analyzer data by way of a standard data source interface card.

### **It's Really Real-Time**

To appreciate the contribution of the analyzer more easily, perhaps one should recall the way in which audio spectrum measurements formerly had to be made. Beginning with a magnetic tape recording of the sound to be analyzed, band levels would be measured, one at a time, by playing the sound back into appropriate filters. Thus the procedure involved much repetition and many different filters. Also, this approach was subject to error if the duration of measurement were too small. Then one might have solved the problem by constructing a tape loop, sometimes playing it at a higher speed (this

involves frequency transformation) so as to overcome the response-time characteristics of the filters. If one were interested in spectrum analysis in anything like real time, of course, this approach was hopeless.

## **What the System Can Do**

The three examples which follow illustrate a few of the many kinds of data processing that are possible for the analyzer-computer combination. The first example, autoranging, demonstrates the usefulness of two-way communication between the analyzer and the computer. The second example, dumping, shows how the processor may be used as a fast data acquisition system. The long-term integration application is one which displays optimal use of the advantages of both analog and digital equipment.

Following these three examples, several practical applications will be described.

### **Autoranging**

Autoranging can be accomplished by treating it as a subroutine within a main program. In essence, the com-



puter scans 24 consecutive channels, finds the maximum band sound pressure level, compares it with the upper and lower limits in the current range, and then makes one of the following decisions: no change in range, change to next more sensitive range, or change to next less sensitive range. If the decision is to change the range of the analyzer this is accomplished by an instruction to the duplex register. Usually, once the range is changed, a certain delay should follow so the transients may die out before more readings are taken. The length of this delay will depend mainly on the time constant of the detectors. One second is more than adequate for a standard instrument operating in the 'rms fast' mode. If it is not important to have a steady scanning rate and an unchanging time delay, these may be managed by auxiliary loops in

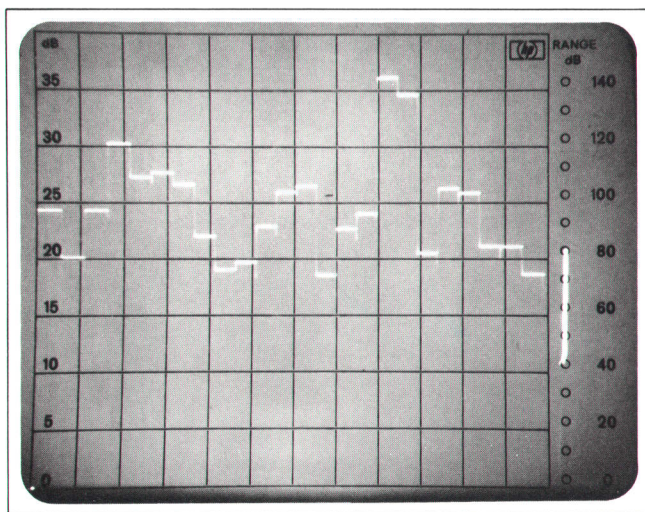

**Fig. 4.** Typical real-time audio spectrum analyzer display (this one is for a single handclap). Standard center frequencies for the 24 bands are 50 Hz to 10 kHz, but optional frequencies range from 2 Hz to 40 kHz. The vertical bar at the right side of the display shows which 40 dB 'window' of the analyzer's 140 dB range is being displayed.

the software. When accurately known timings are essential, as for example in measurements for certification of aircraft, a time-base-generator card may be plugged into the computer.

#### Dumping Band Level Recordings

The analyzer can measure band levels at a rapid rate and deliver the information rapidly. One way to record this information would be to use a printer. With the HP Model 5050B Digital Printer, 24 band levels can be

printed out in 1.2 seconds. However, by using the printer's storage option, this time can be cut in half. With this option, two band levels are recorded on each line.

A much faster rate than this is possible by using the combination of analyzer and computer, taking advantage of the computer's fast memory. Assume one is interested in reading one scan of 24 band levels every 0.1 second, each band level being represented by four ASCII characters. Actually, the analyzer can provide the band levels still more rapidly, but this is seldom a requirement in practice. Since even a high-speed punch operating at 120 characters per second is too slow for our requirements, we simply store the information in the computer memory. 200 such scans can be stored in an 8 K computer, and the information can later be punched on paper tape. At the extreme, packing two band levels in a single memory word, it should be possible to store 9,600 band levels in the memory. The punched tapes can be retained as records; this is mandatory if the signals are to be processed according to several different procedures.

#### Long-Term Integration

In the analyzer, band levels are obtained by using quasi-rms detectors. These are entirely appropriate for measurements with small time constants (the standard instrument uses 100 milliseconds in the 'rms fast' mode). However, for long-term integration (i.e., long-term rms evaluation or long-term averaging), a digital approach may be more suitable. In this example, assume again that we read the 24 band levels every 0.1 second and want to form, in real time, the long-term effective value over seconds, minutes, hours, days or more. By definition, the effective value  $V_{eff}$  of a signal  $V(t)$  over a period of time  $T$  is given by:

$$V_{eff} = \left( \frac{1}{T} \int_0^T V^2(t) dt \right)^{1/2}$$

Replacing the signal  $V(t)$  by instantaneous samples of its level  $L_i$  in dB, it can be shown that the long-term level  $\bar{L}$  is given by

$$\bar{L} \simeq 10 \log_{10} \left( \frac{1}{T} \sum_{i=1}^n 10^{0.1L_i} \Delta t \right),$$

where  $T = n\Delta t$ .

The speed with which this expression will be computed depends mainly upon the speed of the exponential routine. If we assume an average time of 8 ms, we need about 0.2 second just to calculate exponentials for the 24 band levels. It will then be impossible to attain one scan every 0.1 second. But there is another approach to



this problem. Band levels from the analyzer lie between 0.1 dB and 140.0 dB. With a resolution of 0.1 dB there are 1400 different band levels that can be read. Exponentials for these levels can be computed once and for all, and then stored in an array. Now the repetitive operations are simply fetching and additions. Dividing and extracting logarithms will only be required just before printing the results. This process can easily be performed between band level readings. Indeed, it is even possible to increase the channels to 36, and still scan each channel every 0.1 second. Using the switch register on the front panel of the computer, many variations of the procedure can be programmed. For example, a program can be written so that if the operator actuates switch number 15, long-term integration will be interrupted and the system will print the time of interruption and the level computed at that time.

### Using the Audio Data Processor System

The following examples illustrate how the Model 80501A Audio Data Processor can be used to solve

complicated problems in real time. The first example is a detailed description of aircraft noise evaluation, and the other two examples are brief indications of how the system can be used in vibration and speech analysis.

#### Aircraft Noise Evaluation

Aircraft certification<sup>[4]</sup> involves extensive manipulation of a considerable amount of data. The recommended procedure is based on a method devised by Kryter<sup>[5]</sup> and is described in ISO Recommendation R507<sup>[6]</sup> and its latest amendment, ISO DR1760. The analyzer-computer combination can collect the data and reduce it according to this procedure in real time. So far as is known, the HP 80501A is the first commercially available system to be able to do this.

Briefly, the steps involved are these:

- 1) The signal is analyzed into 24  $\frac{1}{3}$ -octave bands and the band sound pressure levels are measured.
- 2) The corresponding 24 perceived noisiness values (n) are computed. This is done by reference to a conversion table called the Noy table, which consists of

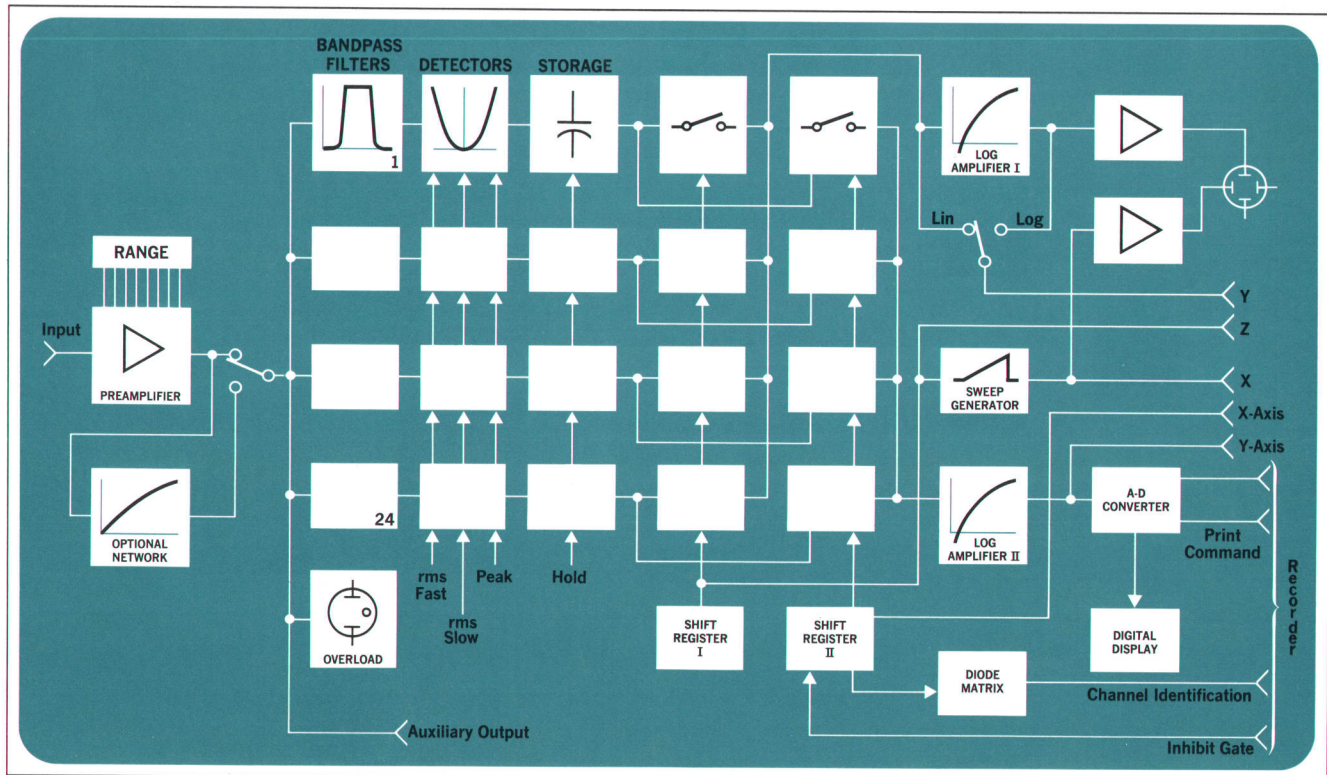

**Fig. 5.** Model 8054A Real-Time Audio Spectrum Analyzer has rms detectors with time constants of 0.1 and 1 second; they can measure signals which have crest factors up to 5. The 'hold' mode freezes the display, and the 'peak' mode captures and holds the peak values of single-shot transients.



24 columns (each corresponding to a center band frequency) and 122 rows (corresponding to band levels of 29 through 150 dB in 1 dB steps). The Noy is a measure of annoyance. The computer stores the Noy table as an array of 2928 words.

3) The perceived noisiness values  $n$  are converted into total perceived noisiness  $N$ , defined as

$$N = n_{max} + 0.15 (\Sigma n - n_{max}).$$

4) The perceived noise level PNL is computed, using the formula

$$PNL = 10 \log_2 N + 40 \text{ dB}.$$

5) The tone-corrected perceived noise level, PNLT, is computed. A broadband noise is more annoying when it contains observable discrete tones. To define the presence of such a tone, the procedure compares each band level with those of neighboring bands. The channels at each end must be treated differently, and tone correction depends upon the center frequencies of the discrete tones, so tone correction would be exceedingly time-consuming if it were done manually.

6) The procedure is repeated every 0.5 second, up to computation of the tone-corrected perceived noise level.

7) The effective perceived noise level, EPNL, is computed. EPNL depends upon the time history of the noise; for the same maximum PNLT, the effective perceived noise level varies with the duration of the excess noise or the width of the peak in the PNLT-vs-time curve. The equation for computing EPNL, using the 10-second normalizing time that is standard for aircraft noise measurements, is

$$EPNL = 10 \log_{10} \left[ \frac{1}{20} \sum_i 10^{0.1 PNL T_i} \right] \text{ dB},$$

where the  $PNLT_i$  are the instantaneous PNLT values computed every half second. All values of  $PNLT_i$  which are within 20 dB of the maximum PNLT are used in this calculation.

Measurements can be started well before a flyover. The system stores only the latest 120 values (60 seconds) of  $PNLT_i$ , shifting in a new value every half second and moving the old values in the computer's memory to make room for the new one. After the maximum PNLT is detected the system keeps shifting until the maximum is near the center of the 60 second 'real-time window' and the noise level has decreased to

( $PNLT_{max} - 20$  dB), as illustrated in Fig. 6. Then the system prints out EPNL and either PNLT values or a PNLT histogram (see Fig. 7). To do all this manually for a one-minute flyover may easily consume many hours or days.

The audio data processor is not, of course, confined to the procedure just described. Loudness may be computed using Steven's procedure<sup>[7]</sup>, or a subroutine may be composed to evaluate A-, B-, C-, and D-weighted levels<sup>[8]</sup>. The system could readily be used to measure truck and bus noises, according to SAE standards<sup>[9]</sup>. Programming may be in assembler, FORTRAN, or ALGOL languages, or the more conversational BASIC language, which is often more convenient<sup>[10]</sup>. By using appropriate drivers in the compiler, the analyzer can be called on to make measurements during a program, and exceedingly complex setups can be reduced to a few simple statements.



**Wisnu T. Kapuskar**

Wisnu Kapuskar graduated from the University of Jabalpur, India, in 1958 with the degree B.E. (Honours). He worked on an M. Tech. degree in industrial electronics at the Indian Institute of Technology, Bombay, until mid-1959, then went to the Technical University of Dresden, Germany, where he received his Dr.-Ing. degree in 1964. After a year of vibration research in Dresden

and a year as an assistant professor at the Engineering College of Nagpur, India, Wisnu came to HP in 1966. He developed precision condenser microphone systems before becoming group leader for computerized systems. In addition to acoustical systems, he has recently been concerned with applications of computers in gas chromatography.

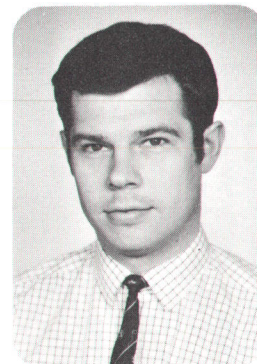

**Chris J. Balmforth**

Chris Balmforth graduated from Manchester University with an Honours Degree in electrical engineering in 1964. After a year of postgraduate studies at the Technical University of Darmstadt, he worked for two years as a software engineer, then joined HP at the beginning of 1968. Since then he has been leading the project for computerized acoustical systems.



**Fig. 6.** Aircraft certification requires computation of effective perceived noise level (EPNL) according to ISO R507. Computation of tone-corrected perceived noise levels (PNLT) every 0.5 second is a part of this procedure. Model 80501A Audio Data Processor computes PNLT and stores the latest 120 values until the maximum PNLT occurs as the aircraft flies over the test point. The system then computes EPNL using the PNLT values in the white area.

**Fig. 7.** After computing EPNL, Model 80501A prints out EPNL and either PNLT values or a PNLT histogram like this one.

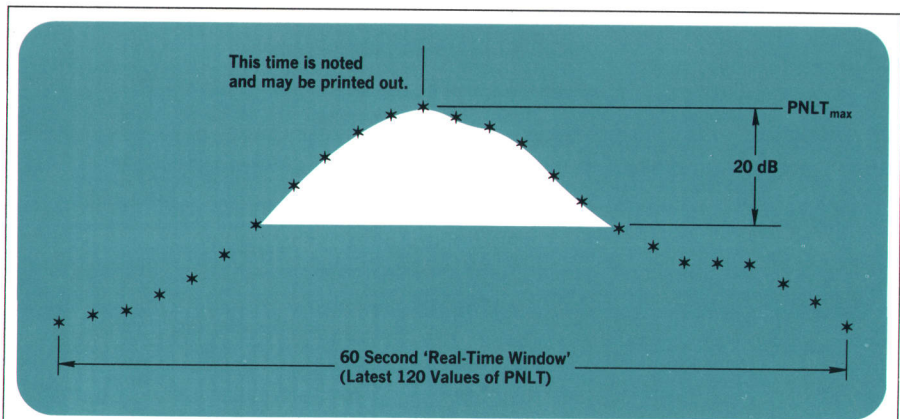

THIS PROGRAM PERFORMS A COMPUTATION ON READINGS OBTAINED FROM THE HP 8054A REAL TIME AUDIO SPECTRUM ANALYZER. THE PROCEDURE ADOPTED CONFORMS TO THE ISO RECOMMENDATIONS 507 FOR DESCRIBING AIRCRAFT NOISE AROUND AN AIRPORT.

```
CORRECTION FACTOR ?                (+ OR -) XX.X DB
1.5
INTERVAL BETWEEN MEASUREMENTS ?      X.X SECONDS
0.5
TO START MEASUREMENTS HIT RUN
PAUSE
```

```
MAXIMUM PNLT OCCURED AFTER 10.5 SEC.
MAXIMUM TONE CORRECTED PERCEIVED NOISE LEVEL= 123.2 DB
EFFECTIVE TONE CORRECTED PERCEIVED NOISE LEVEL=121.4 DB
```

HISTOGRAM OF PNLT VALUES\*\*

```
05.5 ***** 111.2
06.0 ***** 111.8
06.5 ***** 114.2
07.0 ***** 116.3
07.5 ***** 116.5
08.0 ***** 116.9
08.5 ***** 117.1
09.0 ***** 118.2
09.5 ***** 119.9
10.0 ***** 120.0
10.5 ***** 123.2
11.0 ***** 121.2
11.5 ***** 121.2
12.0 ***** 120.7
12.5 ***** 122.1
13.0 ***** 123.1
13.5 ***** 122.8
14.0 ***** 122.5
14.5 ***** 122.3
15.0 ***** 122.2
15.5 ***** 120.6
16.0 ***** 119.0
16.5 ***** 117.4
17.0 ***** 116.1
17.5 ***** 114.9
18.0 ***** 111.5
18.5 ***** 109.7
19.0 ***** 108.4
19.5 ***** 106.8
20.0 ***** 105.4
20.5 ***** 104.5
21.0 ***** 103.6
```

## Engine Testing and Maintenance

Engine faults can often be recognized by analyzing the spectrum of the noise they produce. Here there are no 'recommended' approaches and no standard software. If a user can define his problem in terms of  $\frac{1}{3}$ -octave analysis, the audio data processor might, for example, compare the noise spectrum of the engine under test to the spectra of known-faulty engines stored in the computer's memory. The computer might then diagnose the faults, if any, and print out the results.

This same comparison method might be used to analyze vibrations produced by any type of rotating machinery to determine its operational condition. For the manufacturer, this might mean better quality control and lower warranty costs. For the user, the result might be more effective preventive maintenance, less downtime, and lower maintenance costs.



## Speech Analysis

For speech analysis, as for engine analysis, there are no 'recommended' approaches and no standard software for the 80501A system. Much research in this field remains to be done, and we can only indicate some of the possibilities. By comparing the spectra of an unknown person's speech or verbal commands to known spectra in the computer's memory, the audio data processor may be able to recognize individuals or perform calculations and solve problems from verbal commands. Sounds of military interest, possibly other than human speech, can sometimes be analyzed and classified or recognized by the system. Many other possibilities exist; the variety of the system's uses in speech analysis, as in the other application areas, is restricted only by the imagination of the user. 

## References

- [1]. H. Blässer and H. Finckh, 'Automatic Loudness Analysis,' **Hewlett-Packard Journal**, Nov. 1967.
- [2]. E. Zwicker, 'Ein Verfahren zur Berechnung der Lautstärke,' *Acustica* 10 (1960), p. 304.
- [3]. W. E. Ohme, 'Loudness Evaluation,' **Hewlett-Packard Journal**, Nov. 1967.
- [4]. 'Aircraft Noise Evaluation,' Federal Aviation Administration, Report No. FAA-NO-68-34.
- [5]. K. D. Kryter, 'Concepts of Perceived Noisiness, Their Implementation and Application,' *Journal of the Acoustical Society of America*, Vol. 43, No. 2, Feb. 1968, pp. 344-361.
- [6]. 'Procedure for Describing Aircraft Noise Around an Airport,' International Organization for Standardization, ISO Recommendation R507, April 1968.
- [7]. 'Procedure for Calculating Loudness Level,' International Organization for Standardization, ISO Recommendation R532.
- [8]. 'Recommendation for Sound Level Meters,' IEC 123. 'Specification for Precision Sound Level Meters,' IEC 179. 'Specification for General Purpose Sound Level Meters,' US Standard S1.4 - 1961.
- [9]. 'Measurement of Truck and Bus Noise,' Society of Automotive Engineers Standard SAE J672.
- [10]. G. L. Peterson, 'BASIC—the Language of Time-Sharing,' **Hewlett-Packard Journal**, Nov. 1968.

## SPECIFICATIONS

### HP Model 8054A

#### Real-Time Audio Spectrum Analyzer

**FREQUENCY RANGE:** Twenty-four  $\frac{1}{3}$ -octave filters with center frequencies from 50 Hz to 10 kHz. Other  $\frac{1}{3}$ -octave filters with center frequencies from 2 Hz to 40 kHz are available on special order.

**FILTER CHARACTERISTICS:** Attenuation outside the passband at  $0.79 f_0$  and  $1.26 f_0$ : typically 20 dB  
at  $0.5 f_0$  and  $2 f_0$ : typically 50 dB  
at  $0.25 f_0$  and  $4 f_0$ : typically 70 dB  
All filters meet the requirements of international standards (IEC 225, USAS S1.11-1966, Class III)

\*  $f_0$  is the center frequency of the passband,  $0.79 f_0$  and  $1.26 f_0$  correspond to the center frequencies of the adjacent  $\frac{1}{3}$ -octave filters.

#### READOUT:

**CRT DISPLAY:** 40 dB display range, calibrated in dB (5 dB/div.) with internal graticule. Range indicated. Two channels per horizontal division.

**DIGITAL DISPLAY:** Four-digit readout of selected passband level in dB above 1  $\mu$ V. Resolution of 0.1 dB.

**AMPLITUDE RANGE:** 0 to 140 dB above 1  $\mu$ V. (1  $\mu$ V to 10 V). The 40 dB dynamic range displayed on the CRT can be shifted in 10 dB steps over the entire amplitude range. Peak noise < 15 dB for each channel from 50 Hz through 10 kHz.

#### DISPLAY MODES:

**RMS SLOW and RMS FAST:**  
Dynamic characteristics of rms modes as specified in IEC 179. Other combinations of rms time constants between 100 milliseconds and 100 seconds are available on special order.

**PEAK:** Rise time of the peak detector is less than 4 milliseconds.

**HOLD:** Storage of the instantaneous CRT display can be accomplished in any of the above modes by pressing the HOLD pushbutton.

#### ACCURACY:

##### RMS MODE:

**DIGITAL DISPLAY:** For steady sine wave signal at filter center frequency:  $\pm 1$  dB in upper 30 dB of display,  $\pm 1.5$  dB in lower 10 dB of display. For random noise signals:  $\pm 0.2$  dB referred to sine-wave accuracy. For tone burst signals with crest factors less than or equal to 3 at ac-dc converter inputs:  $\pm 1$  dB referred to sine wave accuracy. For signals with crest factors between three and five at ac-dc converter inputs:  $\pm 1.5$  dB referred to sine wave accuracy.

**CRT DISPLAY:**  $\pm 1$  dB referred to digital display accuracy.

##### PEAK MODE:

**DIGITAL DISPLAY:**  $\pm 1$  dB in upper 30 dB of CRT display

referred to steady sine wave rms accuracy,  $\pm 1.5$  dB in lower 10 dB of CRT display referred to steady sine wave rms accuracy.

**HOLD MODE:** Displays change by less than  $\pm 1$  dB/hr at full scale, less than  $\pm 1$  dB/min at bottom scale.

#### SCANNING:

**MANUAL/REMOTE:** Any channel can be selected manually by front panel pushbutton, or remotely by contact closure to ground. The digital display indicates the band level, and the channel is identified by illuminating the relevant channel button and brightening the respective zone on the CRT display.

**X-Y RECORDER:** Automatic sequential scanning at a rate of 1 s/channel of all 24 channels provides analog outputs suitable for processing by standard X-Y recorders. Scanning can be repeated by remote control.

**EXT. INHIBIT:** The rate of scanning is controlled by the hold-off signal (voltage greater than 10 V) from the digital recorder or computer which is processing the BCD output. The scanning is sequential and continuous. A maximum scanning rate of 1 channel/ms can be achieved with a relatively fast computer.

**PRINT 1 CYCLE:** This mode is similar to EXT. INHIBIT, but only one sequential scanning of the twenty-four channels is completed. Scanning can be repeated by remote control.

**RESET:** X-Axis and Y-Axis outputs are grounded; digital outputs produce blanking signals.

#### INPUTS:

**INPUT A:** Directly calibrated in dB of sound pressure level for microphones with a nominal sensitivity of 5 mV/ $\mu$ bar. Microphone correction factors from -1 dB to +4.5 dB can be compensated for in 0.5 dB steps by a rear-panel switch. A built-in power supply provides a 200 V polarization voltage for condenser microphones and operating voltage for preamplifiers. Up to 12.5 mA can be supplied for the preamplifier and additional cable amplifiers. The input connector is a three-pin Cannon type XLR-3-31 audio connector. Input impedance is 100 k $\Omega$ .

**INPUT B:** Directly calibrated in dB above 1  $\mu$ V. BNC input connector. Input impedance is > 100 k $\Omega$ . The input amplifier has an overload capability of approximately 30 dB.

#### OUTPUTS:

**ANALOG X-Y RECORDER:**  
**X-AXIS:** 200  $\pm 30$  mV/channel  
Output impedance: < 20  $\Omega$ .  
BNC connector.

**Y-AXIS:** 0 to 3 full scale, calibrated in dB.  
(200 mV/dB)  
Output impedance: < 20  $\Omega$ .  
BNC connector.

**PEN LIFT:** Contact closure to operate 'Pen'. Telephone jack.

**EXT. OSCILLOSCOPE:**

**X:** Linear Ramp 0 to about 8 V.  
Output impedance: < 20  $\Omega$ .

BNC connector.

**Y:** Pos. 'Log' 200 mV/dB.

Pos. 'Lin' 8 V full scale.

Output impedance: < 20  $\Omega$ .

BNC connector.

**Z:** Provides blanking pulse of +6 V open circuit dc coupled.

Output impedance: < 15 k $\Omega$ .

BNC connector.

**AUXILIARY OUTPUT:** Output of Input Amplifier.

**GAIN RANGE:** -40 dB to +60 dB in 10-dB steps. Accuracy:  $\pm 0.2$  dB.

**MAXIMUM OUTPUT SWING:** 10  $V_{pp}$ .

**OUTPUT IMPEDANCE:** < 20  $\Omega$ .

BNC connector.

#### DIGITAL OUTPUTS:

**CONNECTOR TYPE:** Amphenol 57 - 40500 (50-Pin).

**MATING CONNECTOR:** Amphenol 57 - 30500.

**CODE:** 1-2-4-8 BCD '1' state positive.

'0' level: 0 V nominal;

'1' level: +5 V open circuit, nominal;

Source impedance: 7.5 k $\Omega$  max. each line.

**REFERENCE LEVELS:** Ground; +5 V, low impedance.

**PRINT COMMAND:** Step from 0 V to +6 V, dc coupled, 20  $\mu$ s minimum duration, 5 V/ $\mu$ s minimum rise rate; source impedance: 100  $\Omega$  maximum.

**HOLD-OFF REQUIREMENT:** Voltage must be more than +10 V. Input impedance: 62 k $\Omega$ .

**ACCURACY OF DIGITAL OUTPUTS AND Y-AXIS OUTPUT:**

(Same as DIGITAL DISPLAY)

**REMOTE CONTROL:** Selection of range, channel, and display mode made by contact closure or saturated NPN transistor to ground.

**ENVIRONMENT:** Ambient temperature 0°C to 50°C and relative humidity to 95% at 40°C. Operation without damage: -20°C to +50°C.

**POWER REQUIREMENTS:** 110 or 220 V -10%,  $\pm 15\%$ , 50 Hz to 400 Hz, approximately 100 W.

**PRICE:** Model 8054A \$8950.00.

Option 01: A MAXIMUM RMS Display Mode replaces the normal PEAK Mode. No charge.

Option 02: A to D converter and digital display not included.

Price: Less \$600.00.

### HP 80501A

#### Audio Data Processor

#### SYSTEM PRICE INFORMATION

For complete system information or a quotation on a system designed to meet your special requirements, call your local Hewlett-Packard field engineer. Price varies with instrumentation and computer peripheral equipment options. The systems are tailor-made to meet individual customer needs and range in price from \$35,000.00 to \$50,000.00.

**MANUFACTURING DIVISION:** HEWLETT-PACKARD GmbH  
703 Böblingen  
Herrenberger Strasse 110  
West Germany



# Monitoring Airport Noise

*Noise control around airports is never easy, but it's next to impossible without up-to-the-minute information about noise levels at critical locations. Here's a computerized system that gathers and processes the necessary data.*

By Wisu T. Kapuskar and Christopher J. Balmforth

JET TRAVEL IS A NECESSITY IN OUR SOCIETY. Unfortunately, jet aircraft are awfully noisy beasts, and no one knows this better than the people living near our larger airports. They are disturbed and annoyed, so much so that the control of noise during takeoffs and landings has become a major problem for airports. To deal with the noise problem, three approaches are being taken. The first is to develop quieter aircraft, the second is to place stricter controls on the planning of airport locations and surroundings, and the third is to develop special flight patterns and techniques for use around airports.

Designing quieter aircraft has the advantage of attacking the problem at its source. The aircraft industry is working closely with government agencies such as the Federal Aviation Agency to develop standards for aircraft noise performance. These standards will become obligatory for future aircraft designs.

The second approach to controlling airport noise, placing stricter controls on the planning of housing around airports, can realistically be applied only to new airports. Since industry likes to locate near airports, and since people like to live near their work, airports tend to attract industry and housing, and planning is required to prevent noise problems. Many of our older airports have problems because there has been little or no planning. In the future we will have to be sure that planners have the data they need to make intelligent decisions about controls.

The third approach to the airport noise problem is to develop special flight patterns and techniques, consistent with safety requirements, to reduce the noise level in those cases where people already live close to the airport. This involves such things as bringing aircraft in on a steeper approach when landing, avoiding flying over certain areas, and taking off under reduced power. In

extreme cases flying hours may have to be restricted to certain hours in the day. This last step is a drastic one, but some airports in Europe have already been forced to take it.

## **Aircraft Noise Monitoring System**

Regardless of which approach is taken to control airport noise, there is a need for monitoring, measuring, and analyzing the noise. Measurement and analysis are the first steps in enforcing standards, in gathering information for planners, and in keeping track of local conditions so flight patterns can be altered to minimize noise.

The HP Model 80500A Aircraft Noise Monitoring System is designed to measure the sound level at a number of locations in or around an airport and then immediately process the data at a central location to provide results in the optimal form for evaluation by relatively untrained personnel. The results can be used to determine effective methods of reducing the annoyance to neighbors of the airport and to detect unusually low flying or deviations from preset flight routes. The system can even identify evasive maneuvers that a pilot might perform to avoid detection. An important advantage of the system is that meaningful results are available while an offending aircraft is still in the vicinity of the airport. Corrective action, such as scheduling an inspection of the aircraft or instructing the pilot to alter his flight path or flying technique, can be initiated as soon as a violation is detected.

The system continuously monitors the noise around an airport, analyzes the sound, and records the results. Whenever sound levels defined as excess occur, the equipment prints out the time of the occurrence, the terminal number at which the excess was observed, the amount and duration of the excess, and calibration information (see Fig. 1). It computes equivalent sound



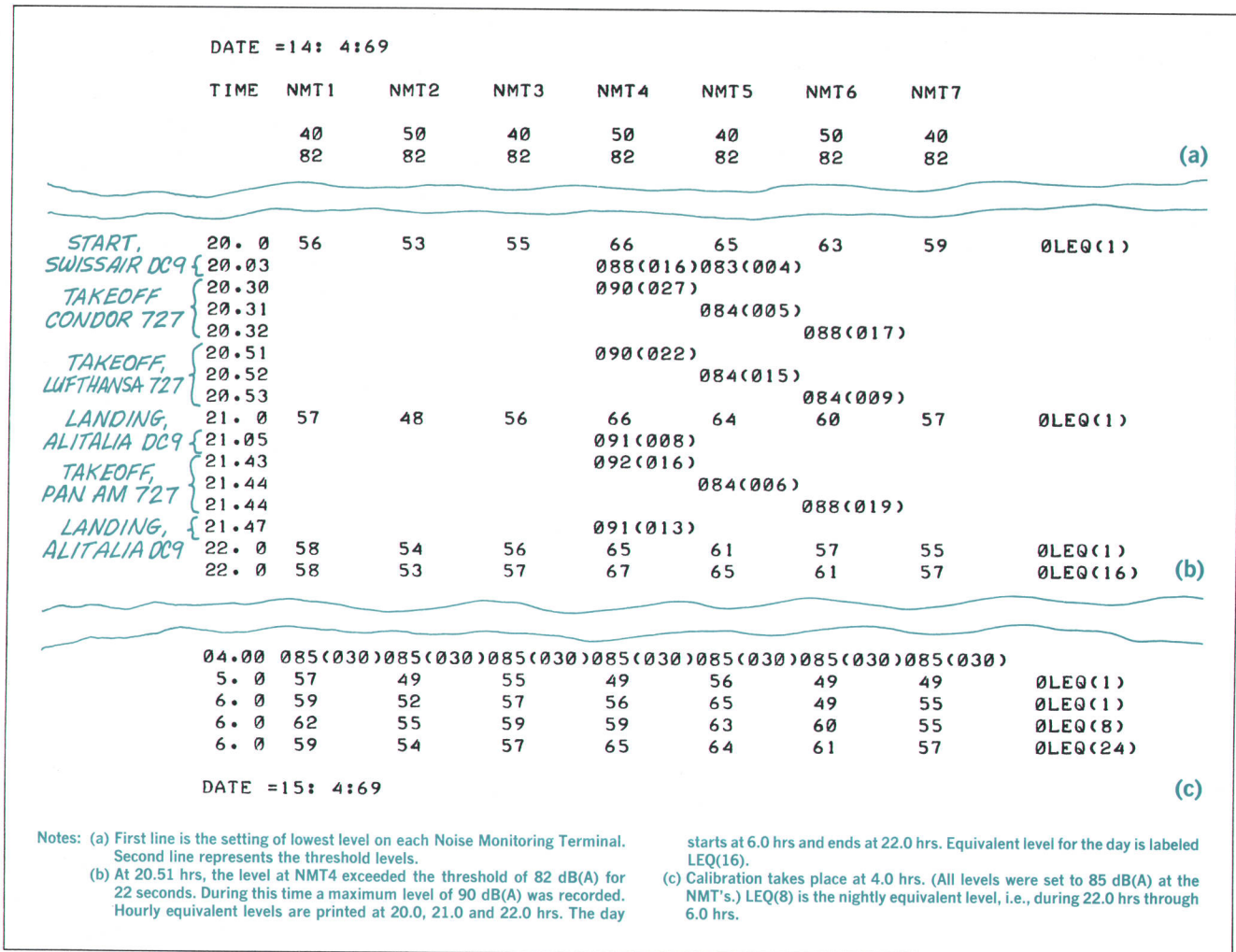

**Fig. 1. Model 80500A Aircraft Noise Monitoring System continuously monitors the noise level at many points around an airport and indicates excess levels immediately so corrective action can be taken. This is a printout for the seven-point system at Stuttgart airport.**

pressure levels hourly and daily, using different weighting factors for day and night observations.

### Three Subsystems

The monitoring system consists of a number of *noise monitoring terminals* and a *central processing unit* containing a digital computer. There can also be one or more *mobile units*, which in their simplest form may consist of a sound level meter and a tape recorder.

### Noise Monitoring Terminal

Each noise monitoring terminal (Figs. 2 and 3) determines the sound pressure level of aircraft noise in its vicinity and sends this information to the central processing unit by telephone line. There can be a large number

of terminals (e.g., 48) in the system and the central processing unit will still be able to sample every terminal once each second.

In the terminal are primarily standard HP instruments. Aircraft noise is picked up by a condenser microphone assembly which is suitably wind- and weather-protected. The microphone assembly consists of a condenser microphone cartridge which produces an output voltage proportional to the incident sound pressure level, and a solid state FET preamplifier which has virtually unity gain, very low noise and low microphonics, a high input impedance and a low output impedance. To protect the microphone from effects of humidity a heater is included. The heat is localized close to the cartridge and a minimum of excess heat is conducted to the solid-state FET preamplifier.



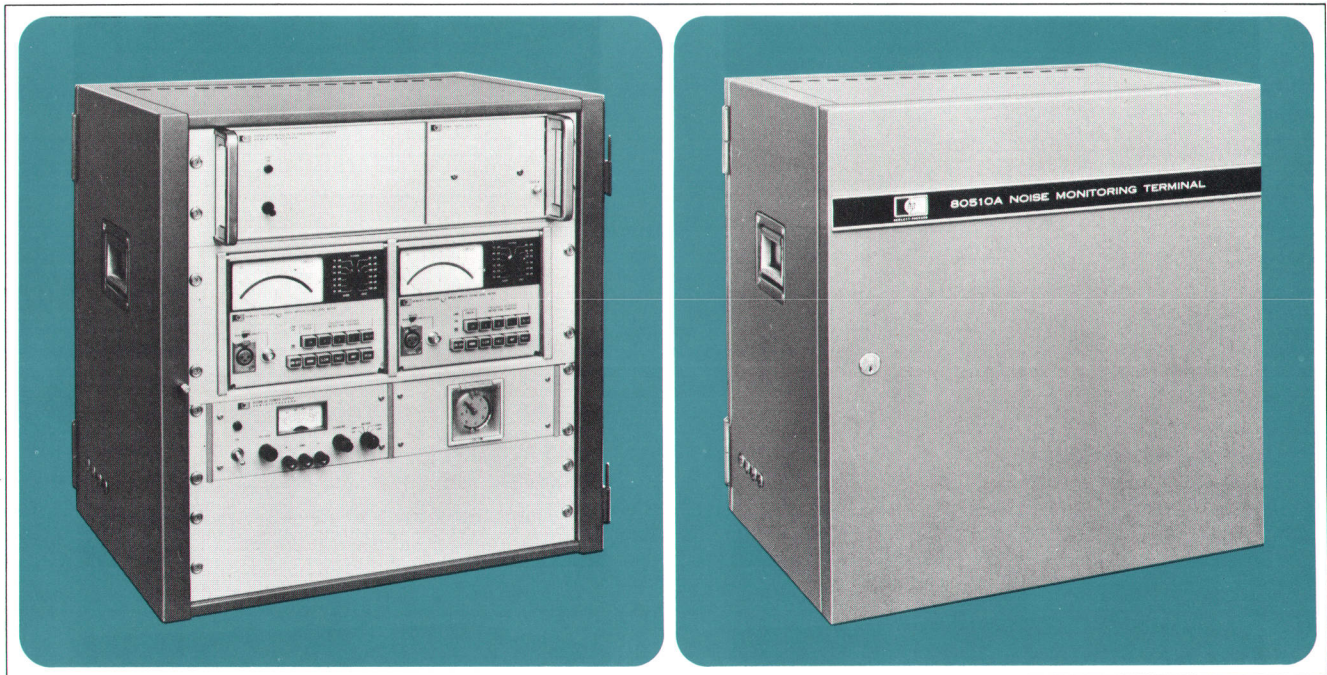

**Fig. 2.** Noise Monitoring Terminals measure noise in their vicinity and transmit it to the central processing unit by telephone line. A Mobile Unit is also available.

The output of the preamplifier goes through a 10 dB amplifier and a bridging transformer which eliminates ground-loop problems. It is then measured by two HP Model 8052A Impulse Sound Level Meters\* operating in parallel, but with a gain difference of 25 dB, so as to cover a dynamic range of 50 dB. The sound level can be measured in dB (A), dB (C), or dB (D), or unweighted dB of sound pressure level; however, dB (A)

\* These instruments meet or exceed IEC recommendations for impulse sound level meters and precision sound level meters.

and dB (D) are most commonly used. Rms measurements can be made for signals with crest factors as high as five.

The voltage outputs of the two impulse sound level meters are combined, amplified, and used to control the frequency of an HP 3300A Function Generator acting as a voltage-to-frequency converter. The output frequency of the function generator is linearly proportional to the sound level in dB (A, C, D, or unweighted); it varies between 900 Hz and 3400 Hz, an increment of 50 Hz

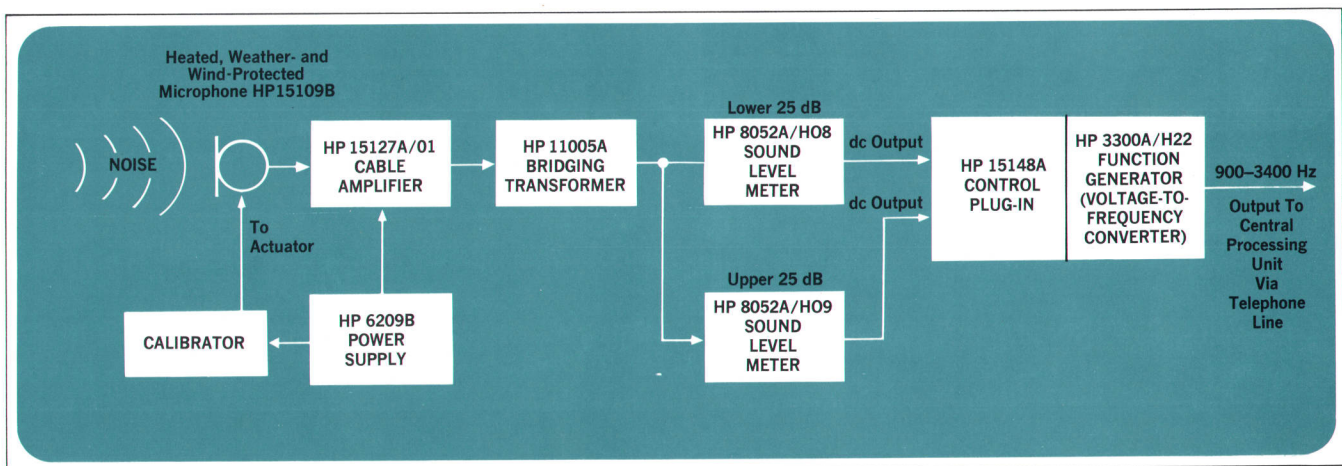

**Fig. 3.** Each noise monitoring terminal has a microphone system (not shown in Fig. 2) and two impulse sound-level meters. It can measure noise levels from 0 to 50 dB above a preset reference level (0 to 75 dB with options).



corresponding to a sound level increment of 1 dB. This signal is then transmitted by telephone line to the central processing unit. In addition to the frequency-coded level information, a part of the original noise can also be transmitted over the telephone line to help the operator identify erroneous signals caused by such sounds as a lawn mower or other sources.

Once a day the noise monitoring terminal is calibrated at a time preset on a built-in time switch. This switch turns on a 1 kHz oscillator and applies it to an electrostatic actuator which is built into the rain cover of the condenser microphone.

### Central Processing Unit

At the central processing unit (Figs. 4 and 5) the telephone lines converge on the monitoring scanner (HP 15143A). Controlled by means of a duplex register in the computer, the scanner selects a channel, amplifies the signal, and applies it to the counter. The same duplex register is used to indicate excess levels (both by visual and by audible signals). As many as eight channels may be handled by a single scanner.

The counter makes a ten-period-average measurement and transmits the measured period to the computer via a standard data source interface card. Signal-to-noise ratio is improved by reading each channel twice and rejecting the lower value. Provisions are made to neglect sonic booms and the like\*, and to indicate faults or failures in noise monitoring terminals. The computer also has a time-base-generator card which is used as a clock to give time of day, month, and year, and to time the scanning intervals.

The computer converts the readings of the counter into sound levels and compares them with the preselected threshold levels for the corresponding terminals. If an

\* Sonic booms that might be caused by supersonic airliners are considered to be more of a national or international problem than a problem of the individual airport.



**Fig. 4.** The central processor can scan each noise monitoring terminal once each second, process the data, and present the results in the optimal form for evaluation by relatively untrained personnel. It can be adapted to future regulations and noise evaluation methods simply by changing programs.

excess is detected the visual and audible indicators are activated, and the maximum noise level and duration of the excess are printed out.

Without a computer, a six-terminal system might require six to eight people to evaluate the data. Not only are these unnecessary with a computerized system like the 80500A, but the computed results are available instantly so airport personnel can communicate with the pilot as soon as excess noise is detected.

The aircraft noise monitoring system is also useful for surveying, that is, for determining total noise exposure at various points, for studying the noise patterns of particular types of aircraft, and so on.

### TENTATIVE SPECIFICATIONS

#### HP Model 80500A Aircraft Noise Monitoring System

**FREQUENCY RANGE:** 20 Hz to 20 kHz.

**AMPLITUDE RANGE:**

- Sound Pressure Level, 55 to 150 dB.
- Sound Level (A-weighted), 40 to 150 dB.
- Sound Level (D-weighted), 50 to 150 dB.

**DYNAMIC RANGE:** 50 dB (75 dB optional).

**ACCURACY:** The accuracy of the Sound Level Meters within the system complies with the requirements of IEC Recommendation 179 for Precision Sound Level Meters. The overall accuracy of the electrical transmission path for a 1 kHz steady-state sine wave as input signal to the Noise Monitoring System is  $\pm 1$  dB.

**WEIGHTING NETWORKS:** The A and C networks modify the frequency response in accordance with specifications of IEC Recommendation 179. The D-weighted network meets the requirements of the draft secretariat revision (Nov. 67) of ISO Recommendation 507.

**DYNAMIC CHARACTERISTICS:** RMS SLOW and RMS FAST dynamic characteristics per IEC Recommendation 179. IMPULSE: Weighted with a 35 ms time constant per the proposed standard for Impulse sound level meters.

**OPERATING ENVIRONMENT:**

- OUTDOOR MICROPHONE SYSTEM:  $-30^{\circ}\text{C}$  to  $+70^{\circ}\text{C}$  at 100% relative humidity.
- NOISE MONITORING TERMINAL:  $-10^{\circ}\text{C}$  to  $+50^{\circ}\text{C}$ ,  $-20^{\circ}\text{C}$  to  $+65^{\circ}\text{C}$  with degraded accuracy, relative humidity up to 95% at  $40^{\circ}\text{C}$ .
- CENTRAL PROCESSING UNIT:  $10^{\circ}$  to  $40^{\circ}\text{C}$  with relative humidity up to 80% at  $40^{\circ}\text{C}$ .
- MOBILE UNIT: 8062A,  $-10^{\circ}$  to  $+45^{\circ}\text{C}$ , relative humidity up to 95% at  $40^{\circ}\text{C}$ .

**POWER REQUIREMENTS:**

- NOISE MONITORING TERMINAL: 115 or 230 V,  $\pm 10\%$ ,  $-15\%$ , 50 to 400 Hz, approximately 100 W.
- CENTRAL PROCESSING UNIT: 115 or 230 V,  $\pm 10\%$ , 50 or 60 Hz, approximately 1500 W.
- MOBILE UNIT: 8062A is powered from two internal rechargeable batteries or external 110 or 220 V,  $-10\%$ ,  $+15\%$ , 50 to 400 Hz, approximately 5 W per 8062A, i.e., 10 W per mobile unit.

**SYSTEM PRICE INFORMATION:**

For complete system information or a quotation on an 80500A Aircraft Noise Monitoring System designed to meet the special requirements at your airport, first call your local Hewlett-Packard field engineer. Naturally, system prices vary with the number of Noise Monitoring Terminals, optional instrumentation, and computer peripheral equipment options. The systems are tailor-made to meet individual customer needs. A typical system might include six Noise Monitoring Terminals, a Central Processing Unit with the 2114A Digital Computer and 8054A Real-Time Audio Spectrum Analyzer, and a Mobile Test Unit including a portable tape recorder. The price for this typical system would be approximately \$70,000.00. Price for a system not using the Analyzer will be about \$10,000 less.

**MANUFACTURING DIVISION:** HEWLETT-PACKARD GmbH  
703 Böblingen  
Herrenberger Strasse 110  
West Germany



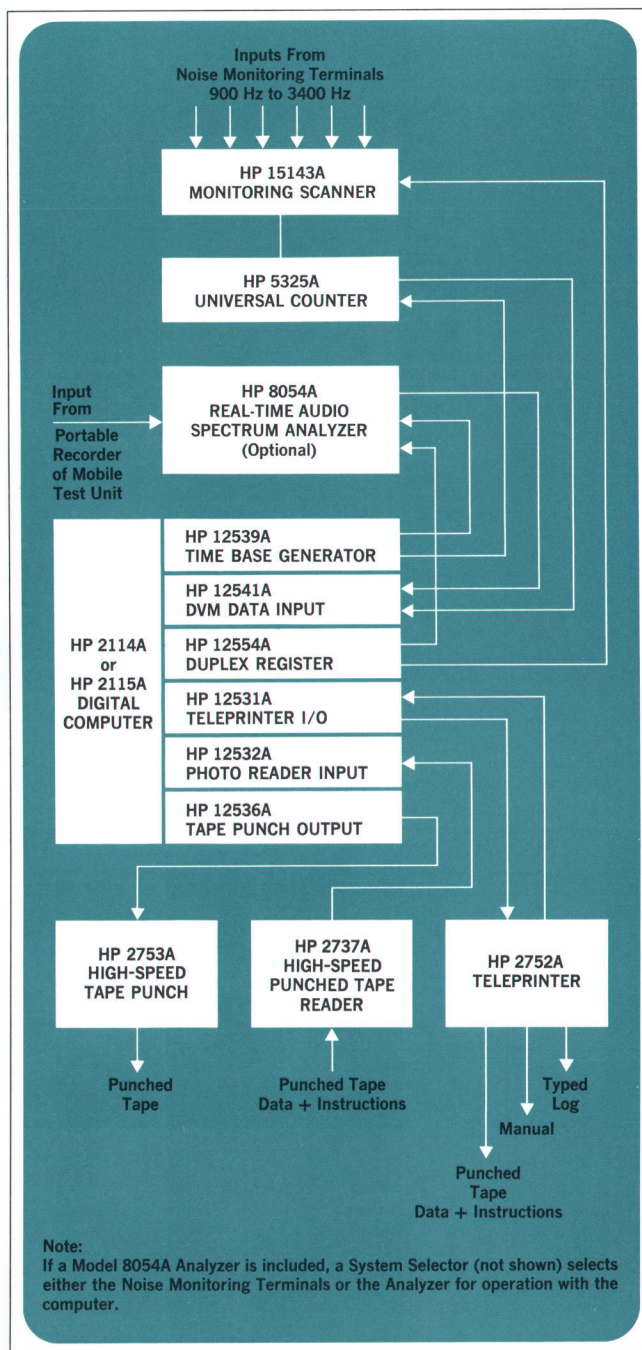

**Fig. 5.** In the central processor are a computer, a scanner, a counter, and peripheral devices. The real-time audio spectrum analyzer is recommended for detailed analysis of recorded noise.

### Standard Software

The standard program for noise monitoring is written in FORTRAN with assembler subroutines. ALGOL and BASIC compilers are also provided with the system. Suitably programmed, the system can conform to existing as well as future laws pertaining to aircraft noise control.

Data and instructions are fed into the system via the teleprinter keyboard or the optional high-speed punched-tape reader. Standard plug-in cards provide the interfaces between the computer and the peripherals. A valuable feature of the aircraft noise monitoring system is that the owner also has a powerful general-purpose computer to use for off-line computations. For normal measurements a minimum of staff attendance is required since the data do not have to be manually processed; results are calculated by the computer and recorded by the teleprinter or tape punch. Tapes may also be processed later to provide additional statistical data or to check the validity of complaints about excessively high noise levels during specified periods of time.

To obtain detailed analyses of recorded noise, the HP Model 8054A Real-Time Audio Spectrum Analyzer can be used (see article, page 2). It is not part of a standard system, however.

### Mobile Unit

This subsystem contains an HP Model 8062A Impulse Sound Level Meter, which is identical to the one used in the Noise Monitoring Terminal except that it contains rechargeable batteries for truly portable operation. Also included is a microphone assembly (HP 15109B) with wind shield, and a precision sound level calibrator (HP 15117A).

Mobile units are typically used to monitor the noise level at points where noise monitoring terminals are not presently located. They may also be used to record aircraft noise on a portable instrumentation analog tape recorder for extensive analysis at a later time. For this purpose a high-quality portable tape recorder (e.g., HP 3960A) plus a battery-operated microphone power supply (HP 15114A) are recommended as additions to the mobile unit.

### Acknowledgments

Thanks are due our engineering manager, Wolfgang Ohme, for his constant encouragement, and our section manager, Heinz Blässer, without whose guidance this project would not have been a reality. There were also many other engineers involved in the development of the system, and I am grateful to all of them for their contributions.



# Network Analysis At Low Frequencies

*Both phase and amplitude information are obtained with a new network analyzer covering frequencies down to 10 kHz.*

By Charles A. Kingsford-Smith



**Fig. 1.** This new HP Model 675A/676A is a low-frequency network analyzer covering the range from 10 kHz to 32 MHz.

SWEPT FREQUENCY MEASUREMENTS have a dynamic quality—there is a continual updating or 'refreshing' of information. This makes the technique appealing to the engineer, since he can watch the results of his successive adjustments to a device or system under test. Swept frequency measurements are important even without phase information.

Adding of phase characteristics to the display completes the device characterization. That is, when the phase and amplitude components of the transfer function are known, the device response to almost any arbitrary signal can be calculated, either in the frequency domain or in the time domain.

A swept measurement system with these useful properties, called a Network Analyzer, is available for the microwave region.<sup>1</sup> For lower frequencies, a new synchronous tracking detector, the 676A, has been designed to operate with the existing HP Model 675A Sweeping Signal Generator.<sup>2</sup> This combination, Fig. 1, becomes a Network Analyzer for the range 10 kHz to 32 MHz. With a low-frequency oscilloscope or an X-Y recorder, the analyzer will display the log magnitude response (over an 80 dB range) and the phase response of the transfer function of a two port device. Using the two identical test channels of the detector, it is also possible to make simultaneous phase and amplitude comparisons of two devices. An accessory, the HP Model 11138A Impedance Adapter, adds the capability of measuring one-port complex impedances in the range 0.3 to 3000 ohms.

The Model 676A is a narrow-band receiver tuned to the instantaneous output frequency of the Model 675A. Synchronous tuning is maintained without phase-locked loops. Rather, a portion of the internal variable frequency signal used to develop the output of the Sweep Generator is supplied to the Model 676A, Fig. 2. In the Model 676A, this signal is converted into a tracking signal always 100 kHz higher than the output of the Model 675A, and this tracking signal serves much the same purpose as the local oscillator in a superheterodyne receiver. It converts the output to a constant 100 kHz IF.

Two problems inherent in a phase lock system—acquiring lock and the limitation on sweep speed, both a result of limited loop bandwidth—are avoided. The price paid, however, is the need to supply the high-frequency synchronizing signal.



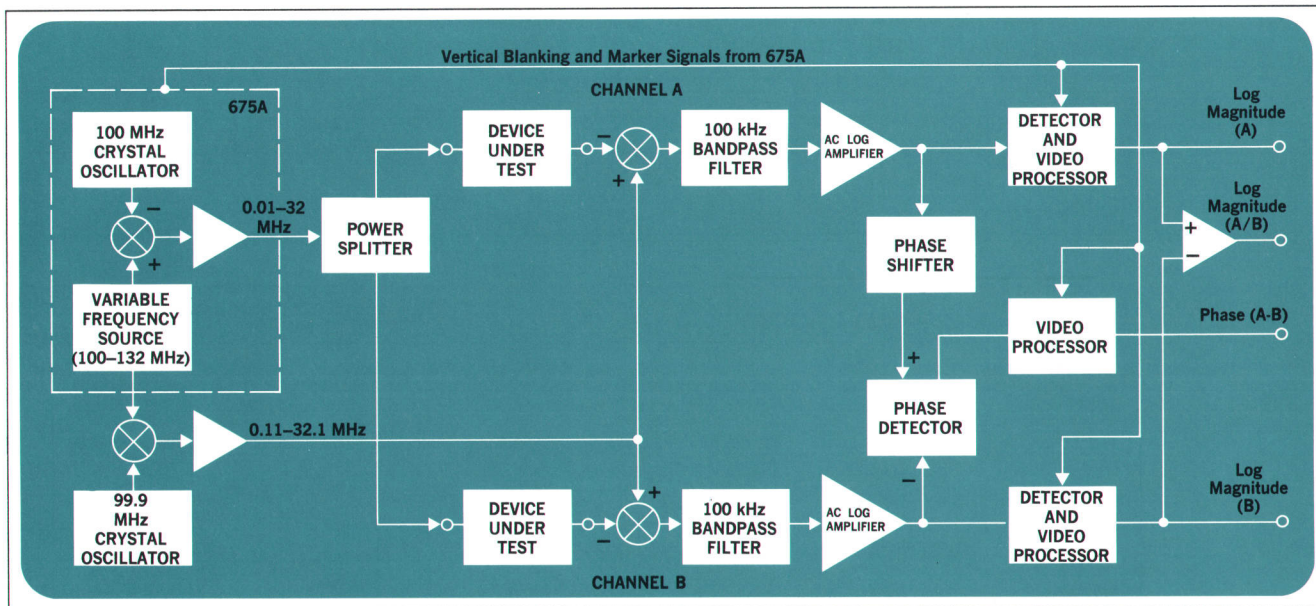

Fig. 2. The RF output of the Model 675A Sweeping Signal Generator is connected to the RF input terminal of the Model 676A Tracking Detector. Phase shift in both channels is equal so that any variation introduced in one channel will appear at the PHASE A-B output.

## Two Measurement Channels

The Analyzer has two identical measurement channels obtained by splitting the output of the Model 675A into signals of equal amplitude and phase, then processing them in identical channels in the Model 676A. An advantage here is that a convenient reference is available for phase measurements. A device to be tested can be connected to Channel A, and a short jumper cable placed in Channel B. The device under test changes the phase of the signal applied to the Channel A input mixer, while the phase of the signal in Channel B is the same as that at the input of the device under test. Therefore, a measurement of the phase difference between the two channels (translated to the 100 kHz IF) gives the phase shift of the device under test.

Two identical channels make phase and amplitude comparisons of two devices possible over a wide dynamic range in applications such as production quality control and incoming inspection. A device may be quickly checked for deviations from a standard, and if the device is adjustable, it is possible to minimize the deviation by proper adjustment.

## Why Convert to IF?

The signal processing—extracting of phase and amplitude information—is performed at the constant IF rather than at the signal frequencies. Why include the additional circuitry needed for conversion when, in prin-

ciple, a dual channel network analyzer could be built to operate directly at the signal frequency? The most important reason is the difficulty of building an accurate phase detector able to operate over a wide frequency range. Also the heterodyne technique simplifies construction of a narrow-band system. When a large dynamic range is used, the harmonic and spurious output from even a clean source could cause false responses in a broad detector. Thus the narrow band system is more desirable.

## Does Phase Shift Shift?

Measuring the phase difference between the two 100 kHz IF signals rather than between the original RF signals raises the question of whether the phase information is preserved through the mixing process. Phase shifts are *not* lost in the mixing process, and to verify this phase measurement scheme it is helpful to observe that a mixer with two inputs may be thought of as a device that adds and subtracts the total phases of its input signals. That is, if the mixer inputs are of the form  $A \cos \phi_1$ , and  $B \cos \phi_2$ , the primary outputs are  $C \cos (\phi_1 + \phi_2)$ , and  $D \cos (\phi_1 - \phi_2)$  where the phase angle has both a time dependent and a fixed component:  $\phi_1 = \omega_1 t + \theta_1$ , and A, B, C, and D are constants. In Fig. 2, each mixer is labeled so that the sense of the input signals with respect to the output is shown. It is the difference output that is selected from the channel input mixers and from the phase detector. Now, we can examine the signal paths, assigning



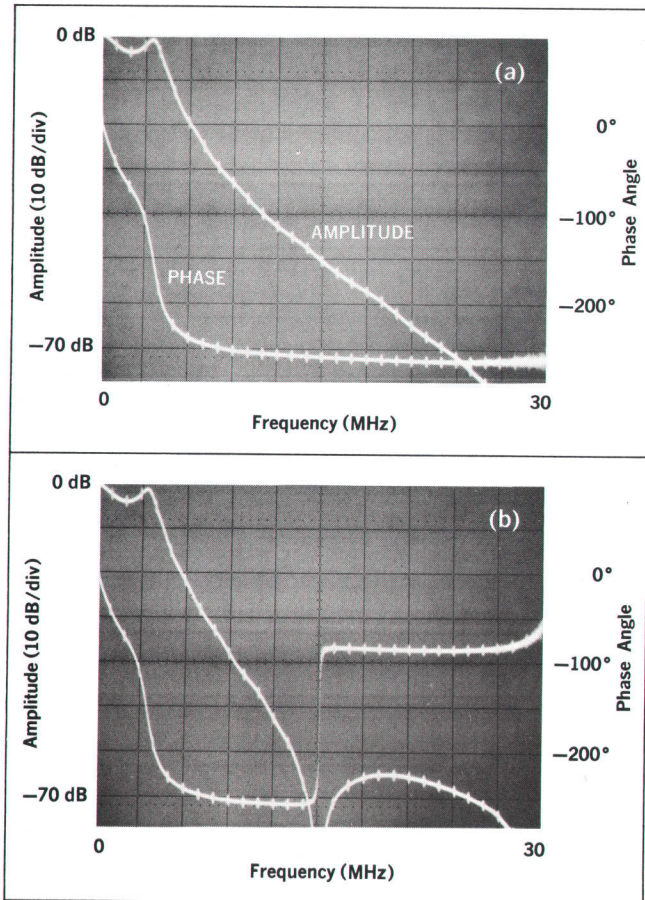
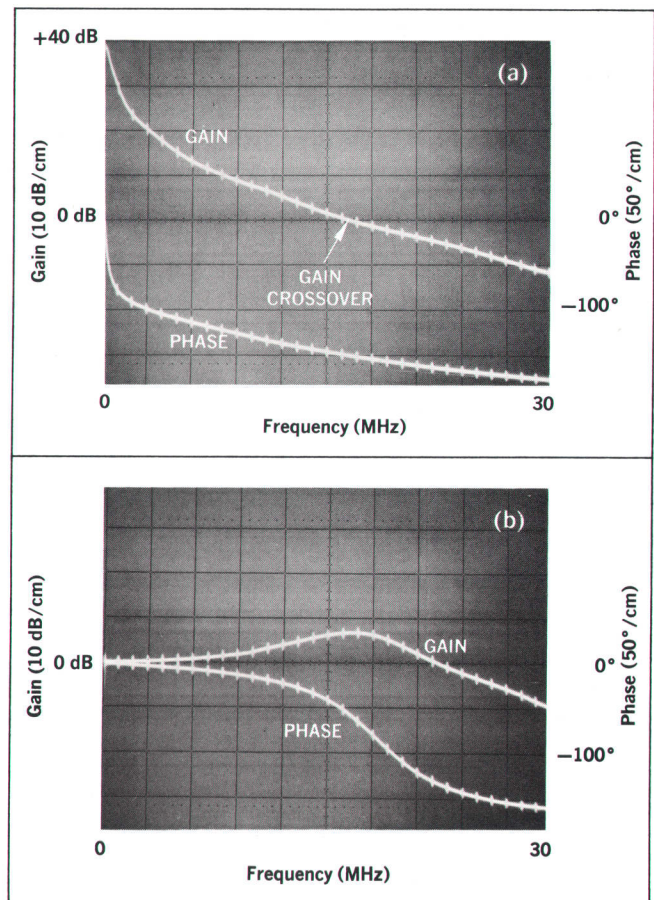

**Fig. 3.** A third order Chebyshev low-pass filter with 3 dB passband ripple and 4 MHz cutoff shows phase nonlinearity in the passband and the nearby stopband (a). The phase tends toward  $-270^\circ$  ( $-90^\circ$  per pole). The same filter (b) modified to produce a transmission zero at 15 MHz shows a characteristic phase shift of nearly  $+180^\circ$  at zero. The second transmission zero just beyond 30 MHz is caused by parasitics. Markers on these scope photos are 1 MHz.

an appropriate phase variable  $\phi_i$ ,  $i = 1, 2, 3, \dots$  to each node. If the phase shifter is set to zero, then the two channels are identical, and the phase variables will cancel in the phase detector output, except the fixed components caused by dissimilarities of the devices under test. Therefore, a given phase difference between the test devices will be translated unchanged through the system.

### Filter Characteristics

The Network Analyzer (without accessories) is designed to measure insertion loss or gain of a two-port device in a 50 ohm system. The Chebyshev low pass filter is typical of filters used in a lab breadboard. In making this measurement, Fig. 3, a 9 inch 50 ohm cable was connected to Channel A and an identical cable to



**Fig. 4.** Open loop characteristics of a video amplifier (a) shows a low-frequency gain of 40 dB, gain crossover at 16.5 MHz and a phase shift at gain crossover of  $150^\circ$ , giving a phase margin of  $30^\circ$ . With unity gain feedback (b) the amplifier shows about 6 dB of peaking.

Channel B (cable length is not important but both should be the same length for phase matching). Using a dual channel scope, the phase and amplitude zero reference lines were set and the calibration of each checked with the Model 675A Attenuator and the internal phase check of the Model 676A. Then the cable in Channel A was removed and the filter connected in its place. The shift of each trace from its reference position revealed the insertion loss of the filter.

### Amplifier Measurements

If the device to be tested shows insertion gain rather than loss, the amplitude reference line must be established at a lower value to avoid overloading the Analyzer. In measurements of a video amplifier, Fig. 4, the Model 675A output attenuator was set to 40 dB to offset this amount of amplifier low-frequency gain, while maintaining the full 80 dB dynamic range of the Analyzer.



## Making Comparisons

Comparing two nearly identical devices is a simple operation. For amplitude comparison, an internal subtractor circuit provides the difference of the amplitude of the analog signals in each channel. Since these are actually log amplitudes, the difference signal is, of course, the log of the amplitude ratio.

Suppose two devices are to track each other within a specified number of dB and within a specified phase angle over some frequency range. Again using two identical cables, the phase and amplitude difference signals are displayed and calibrated. Tolerance limits may be marked on the scope with a grease pencil. In this way, an operator can rapidly compare newly manufactured units with a production standard. Fig. 5 shows the individual and differential amplitudes of two similar low pass filters. The phase shift is not shown, to avoid cluttering the display.

## One-Port Devices

An important class of Network Analyzer applications is the characterization of one-port or driving point impedances. Since this requires other than the basic 50 ohm two-port transfer function capability, an accessory was developed to adapt the Analyzer to this task. The HP Model 11138A Impedance Adapter converts the output signal from the Model 675A into two matched, constant-current sources applied to the test terminals. When test impedances are connected to these terminals, the voltages developed are proportional to the impedances, both phase and magnitude. The voltage across each terminal pair is measured by matched, high-impedance unity gain amplifiers capable of driving the two 50 ohm inputs of the Analyzer. There, the signals are processed as usual to yield the log magnitude and phase indicators. The system is calibrated by using two identical resistances, such as the 100 ohm units supplied, and setting the phase and amplitude lines as before.

It is interesting to observe that the log amplitude scale of the conventional two-port measurement now becomes an 80 dB log ohm scale, from 0.3 ohm to 3 k ohm. The log scale has advantages. For example, see the inherent symmetry in the display of the magnitude of the impedance of the open circuited transmission line of Fig. 6. Neither this display, nor Fig. 7 showing the input impedance of an antenna, reveal the existence of unavoidable terminal impedances (about 40 nH and 7 pF). For accurate measurements near the limits of the magnitude scale at the higher frequencies, these values must be vectorially subtracted from the readings. Parasitic impedances are easy to measure, though, since they trace their

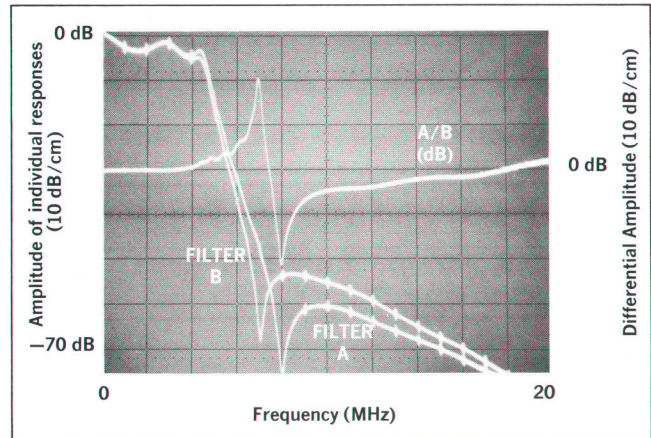

Fig. 5. Two very similar low-pass filters compared using the differential output. Because the signal is the difference of two log amplitudes, it is equivalent to the log of the amplitude ratio.

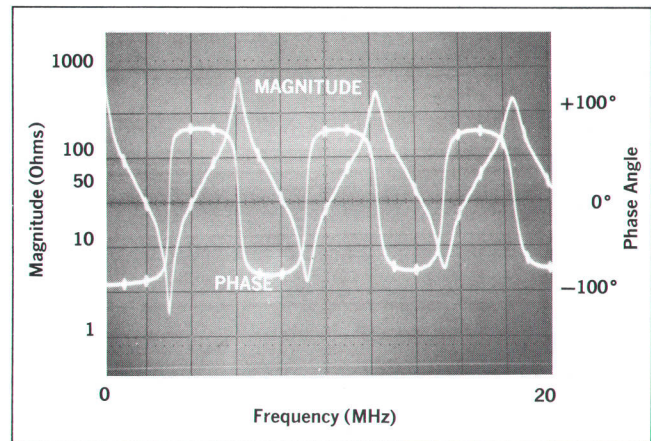

Fig. 6. A 50-foot length of 50 ohm transmission line, open circuited at the far end, exhibits this complex input impedance. Line losses increase with frequency and the phase and magnitude excursions become less pronounced.

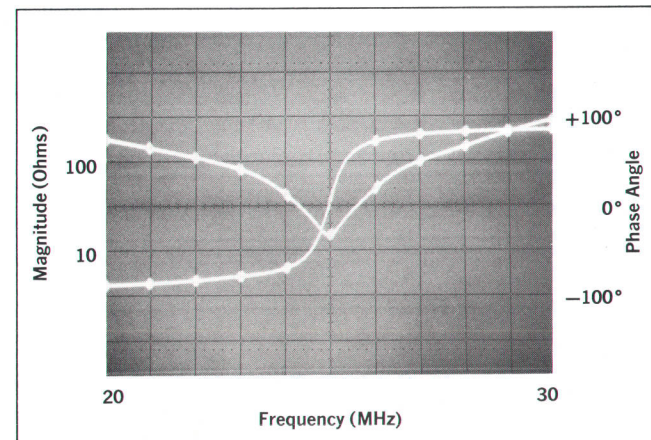

Fig. 7. A two-foot long whip antenna with 2.2  $\mu$ H base loading inductance shows resonance at 25 MHz. The resistive component of its input impedance is about 14 ohms (3 dB above the 10 ohm line).



## SPECIFICATIONS

### 676A Phase/Amplitude Tracking Detector (When used with 675A Sweeping Signal Generator)

**FREQUENCY RANGE:** 10kHz to 32MHz.

**RF OUTPUT (CHANNELS A AND B):** Two equal-amplitude, in-phase outputs derived from 675A output through resistive power divider. All 675A specifications apply except for the following.

Level: +2 dBm (0.28 V rms) into 50  $\Omega$  with 675A set to +13 dBm. Adjustable with 675A attenuator.  
Impedance: 50  $\Omega$  (75 on request). NOTE: Impedance independent of 675A.

Output isolation: 16 dB between channels.

**RF INPUT (CHANNELS A AND B):** Identical inputs synchronously tuned to 675A output frequency.

Level: +2 dBm max (not to exceed +13 dBm or 1 V rms).  
Impedance: same as RF output.  
Crosstalk: >84 dB between channels.

## AMPLITUDE FUNCTION

**RANGE:** 0 to -80 dBm.

**DYNAMIC DISPLAY RANGE:** 25kHz to 32MHz, 80 dB; decreases linearly below 25kHz to 45 dB at 10 kHz.

### ACCURACY:

Using Channel A or B: output proportional to log of input  $\pm 1.5$  dB over 80 dB dynamic range.

Using A-B comparison: can be adjusted for identical Channel A and B performance at any one frequency and amplitude for A-B comparison measurements using external attenuator or other devices.

### SYSTEM FLATNESS

Using Channel A or B  $\pm 0.8$  dB.

Using A-B comparison  $\pm 0.2$  dB.

**NOISE:** < -85 dB (50  $\Omega$  source impedance).

**SPURIOUS RESPONSES:** < -85 dB (50  $\Omega$  source impedance).

**CHANNEL A AND B SCOPE OUTPUT:** 50 mV/dB (+4.2 V dc for +2 dBm input level) adjustable with CAL control.

**A-B SCOPE OUTPUT:** 50 mV/dB ( $\pm 4.2$  V dc for 80 dB channel level difference) adjustable with CAL control.

## PHASE FUNCTION

**RANGE:** 0° to 360°.

### ACCURACY

As a function of frequency: 100 kHz to 32 MHz,  $\pm 1^\circ$ ; 10 kHz to 100 kHz,  $\pm 2^\circ$ .

As a function of amplitude:  $\pm 5^\circ$  over entire 80 dB dynamic range.

**PHASE SCOPE OUTPUT:** 10 mV/° (1.80 V dc  $\pm 1.80$  V dc for 180° with phase control set to 0°). Adjustable with CAL control.

## GENERAL

**POWER:** 115 V or 230 V  $\pm 10\%$ , 50 Hz to 400 Hz, 30 W max.

**WEIGHT:** Net 18 lb (8.2 kg).

**TOTAL SYSTEM WEIGHT:** 58 lb (26.3 kg).

**TOTAL SYSTEM POWER:** 110 W max.

**PRICE** (must order 676A and 675A for Network Analyzer system).

HP 676A, \$1275.

HP 675A, \$2250.

**MANUFACTURING DIVISION:** LOVELAND DIVISION

P.O. Box 301

815 Fourteenth Street

Loveland, Colorado 80537

characteristics on the screen when first shorting, then opening the terminals.

## High Impedance Applications

Where a higher terminating impedance is needed, the HP Model 1123A High Impedance Probe may be used.<sup>3</sup> This is a unity gain active probe with an input impedance of 100 k ohms and 3.5 pF which will drive the 50 ohm input of the Analyzer. It receives its dc power from a jack on the Analyzer panel. The probe is designed primarily for use with the 100 MHz plug-in of the Model 180A/181A Oscilloscopes, so its bandwidth is more than adequate for the Network Analyzer. Its signal delay of about 10 ns (which produces a linear phase component in the Analyzer indication), must be compensated by another Model 1123A or equivalent cable in the reference channel.

## Acknowledgments

Being a member of the 676A design team was a stimulating experience for me, and it is a pleasure to acknowledge these contributions: Paul Thomas did over half the detailed circuit design, achieving significantly better results than preliminary specifications required. Kay Danielson started, then later Art Minich completed the product design. Myles Judd, who suggested a tracking detector for the 675A, was the group leader responsible for both the 675A and 676A. 

## References

- [1]. Richard W. Anderson and Orthell T. Dennison, 'An Advanced New Network Analyzer,' **'Hewlett-Packard Journal,'** February 1967.
- [2]. Robert B. Bump and Myles A. Judd, 'Three and One-Half Decades in One Clean Sweep,' **'Hewlett-Packard Journal,'** January 1968.
- [3]. Eddie A. Evel, 'Voltage Probe for High-Frequency Measurements,' **'Hewlett-Packard Journal,'** November 1968.



## Charles A. Kingsford-Smith

Born in Australia, Chuck was educated in the U.S., receiving his BSEE from Louisiana State University in 1954. He received his MSEE from the University of California in Berkeley in 1962. Previous to joining Hewlett-Packard, he worked on color TV development, and electronic vehicle identification. He also taught electrical engineering at a Brazilian technological institute. Chuck joined HP's

F&T Division in 1965 and transferred to the Loveland Division a year later, where he is now a group leader in signal sources.

His primary hobby is flying. Other interests include ham radio and collecting Bach records.

Chuck holds six patents and has several pending.

## HEWLETT-PACKARD JOURNAL JULY 1969 Volume 20 • Number 11

TECHNICAL INFORMATION FROM THE LABORATORIES OF THE HEWLETT-PACKARD COMPANY PUBLISHED AT 1501 PAGE MILL ROAD, PALO ALTO, CALIFORNIA 94304

Editor: R. H. Snyder Editorial Board: R. P. Dolan, L. D. Shergalis

Art Staff: John C. Allen, Clayton Associates, Director; Maridel Jordan, Assistant